

EVHRP SMALL

High efficiency heat recovery unit
up to 90%

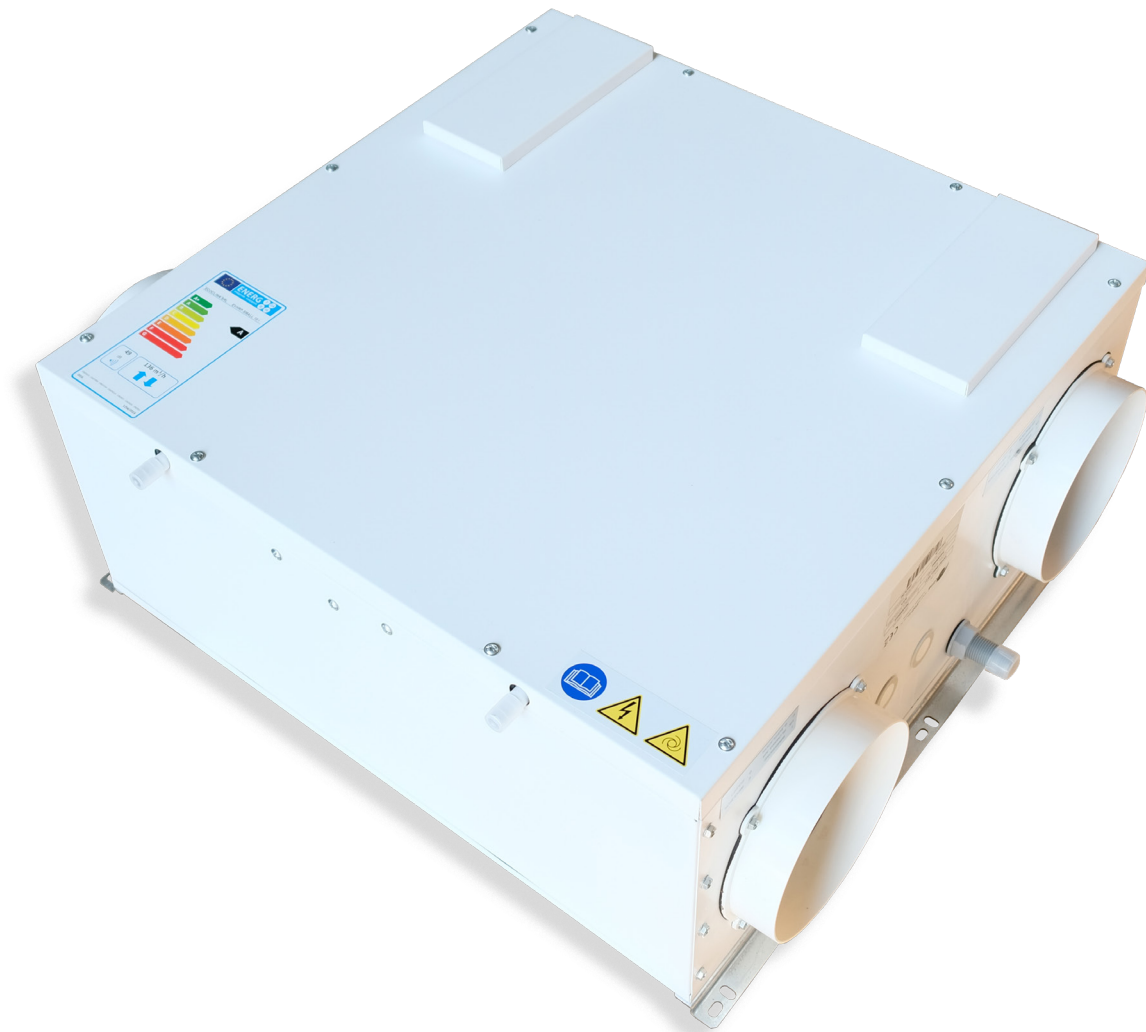

- Horizontal / Vertical installation
- Constant flow rate with 3 selectable levels
- Remote panel with Wi-Fi, integrated humidity / air quality controllers and management via APP

GENERAL FEATURES:

STRUCTURE

High strength structure with frame self-supporting in sheet metal Internal parts in high density EPS



FANS

The unit is equipped with centrifugal fans with low consumption electronic motor and constant flow rate



HEAT EXCHANGER

High efficiency countercurrent cross flow polypropylene heat exchanger.



FILTRATION

Upstream of the recuperator they are present two filters with ePM1 filtration class. Removal can take place without the aid of any tools



BYPASS

The units are equipped with Bypass, which allow the function of fresh air intake only from the outside when there are ideal conditions.



REMOTE CONTROL - WIFI

The unit provides for operation through Remote control and APP;

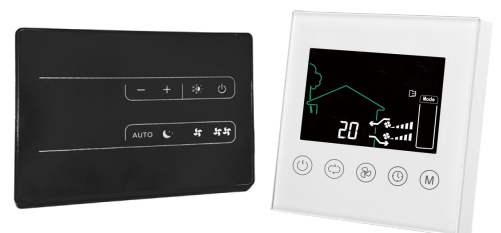

CARATTERISTICHE COSTRUTTIVE:

FRAME	Self-supporting frame in sheet metal Panels in galvanized sheet, painted externally with high density EPS internal insulation; Front aesthetics in composite Aluicobond
HEAT EXCHANGER	High efficiency countercurrent cross flow polypropylene exchanger. Low freezing temperatures Very high exchange efficiency.
FANS	Brushless fans with electronic motor and constant flow control; Very high efficiency and low noise levels.
FREE COOLING	70/80% ePM1 filters with low pressure drop. Easily removable both in horizontal and vertical positioning.
FILTERS	70/80% ePM1 filters with low pressure drop. Easily removable both in horizontal and vertical positioning.
ELECTRICAL CABINET	<p>VERSION IN2 with electronic card for 3-step speed management, anti-freeze function and automatic bypass. Wall-mounted touch remote panel. On-board temperature sensors and hot water auxiliary battery management possibilities. Humidity / air quality regulators integrated in the remote display. EVCNV2-N: advanced remote control with integrated humidity and VOC / CO₂ sensors, black color. EVCNV2-B: advanced remote control with integrated humidity and VOC / CO₂ sensors, white color. EVCNW2-N: advanced remote control with integrated humidity and VOC / CO₂ sensors, with integrated black Wi-Fi. EVCNW2-B: advanced remote control with integrated humidity and VOC / CO₂ sensors with integrated white Wi-Fi. A B configurations selectable by electronics.</p> <p>VERSION S Unit supplied without electronic card; Fan control with 0-10v signal.</p> <p>It is possible to purchase separately the EVT DV remote terminal with LCD display for controlling the speed of the fans and the Bypass with various advanced functions, including:</p> <ul style="list-style-type: none">- control of the speed of the individual fans independently which means that the machine can be used in pressure or depression mode;- timed dirty filter signal;- possibility to connect the EVSQV air quality sensor sold separately.
EFFICIENCY	Thanks to its construction features and its HRP components, DOMO is able to achieve recovery efficiency greater than 90%. In the winter and summer seasons there is a significant energy recovery of the renewal air introduced into the environment.

COMMAND FUNCTIONS

VERSION IN2		VERSIONE S	
ELECTRONIC BOARDS ON BOARD HEAT RECOVERY		EXTERNAL PARAMETRIC REGULATOR	
		EVTDV	
		PARAMETRIC REGULATOR ACCESSORY	
EVCNV Modbus	EVCNW Wi-Fi	Air quality probe EVSQV	
			
<p>Humidity / air quality sensor integrated in the display</p> <div style="display: flex; justify-content: space-around; align-items: center;"> <div style="text-align: center;">  </div> <div style="text-align: center;"> <p>AIR QUALITY</p>  </div> </div>			
EXTERNAL CONTROLS			
 <p>ON / OFF</p>			

REGOLAMENTO ERP :

The regulation, which will come into force from 15 December 2014, defines the energy consumption labels to be applied to the ventilation units and the information to be placed in the

appliance instructions, so that consumers are

fully informed about the consumption and energy efficiency of appliances.

DEFINITIONS: "Ventilation unit" means an electrically powered appliance equipped with at least one impeller, a motor and a casing, designed to exchange exhaust air with air coming from outside a building or part of it. residential ventilation units subject to the obligation are those with a maximum flow rate of 250 m³ / h. The rules are extended to flow rates between 250 and 1,000 m³ / h only if they are intended, as declared by the manufacturer, exclusively for the ventilation of residential buildings. **LABEL:** The label will inform the consumer about the supplier's name or brand, the supplier's model identifier, the appliance's energy efficiency class, sound power level (LWA), in dB and maximum flow rate, in m³ / h. **LIABILITY OF SUPPLIERS.** Suppliers placing residential ventilation units on the market shall ensure that the following conditions are met with effect from 1 January 2016:

1. Each residential ventilation unit is accompanied by a printed label, in the format set out in Annex III , and containing the information indicated therein; the label must be present at least in the unit packaging. For each model of residential ventilation unit, an electronic label with the format and information set out in Annex III is available to distributors;

2. A product fiche is available as indicated in Annex IV. The card is present at least in the unit packaging. An electronic product sheet, as described in Annex IV, is available to distributors and on public websites for each model of residential ventilation unit;

3. the technical documentation set out in Annex V shall be provided upon request to the authorities of the Member States and the Commission;

4. instructions for use are provided;

5. any advertisement relating to a specific model of residential ventilation unit that contains information concerning the energy or the price indicates the specific energy consumption class of that model;

6. Any technical promotional material relating to a specific model of residential ventilation unit, which describes its specific technical parameters, indicates its specific energy consumption class.

RESPONSIBILITY OF THE DISTRIBUTORS: On the other hand, distributors shall:

1. at the point of sale, each residential ventilation unit carries the label made available by suppliers pursuant to Article 3 (1) (a) on the outside of the front or top apparatus so that it is clearly visible;

2. and residential ventilation units offered for sale, for rental or installment sale in situations where the end user is not expected to view the product displayed, are marketed accompanied by the information provided by suppliers pursuant to the annex VI, except if the offer is made via the Internet, in which case the provisions of Annex VII apply;

3 any advertisement relating to a specific model of residential ventilation unit that contains information concerning the energy or the price indicates the specific energy consumption class of the unit;

4 any technical promotional material relating to a specific model, describing the technical parameters of a residential ventilation unit, including the model-specific energy consumption class, as well as the instruction manual provided by the supplier

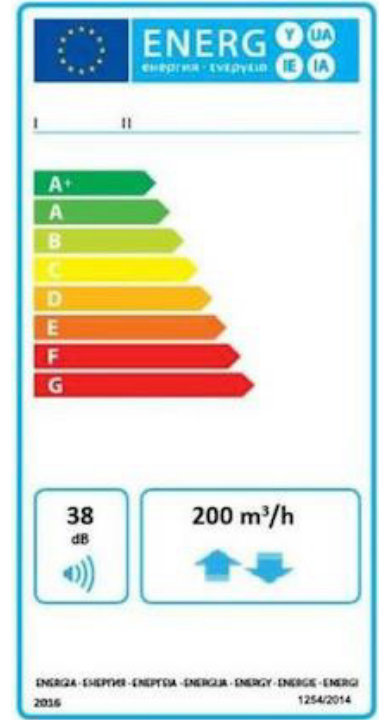

The classification of the various models according to the European regulation 1253/2014 and 1254/2014 is summarized below

ENERGY CLASS UNIT	10 H/V	15 H/V	25 H/V
Version IN BP	A	A	A

UNIT CONFIGURATION:

Model	- 1 -	- 2 -	BYPASS
EVHRP SMALL	10	IN	BP

1) Defines the maximum flow rate

10: up to 130 m³/h

15: up to 210 m³/h

25: up to 320 m³/h

2) Type of control

IN : electronics on the machine with capacitive touch screen display

S: Machine without electronics on board and managed with remote parametric regulator.

CONFIGURATION:

HORIZONTAL INSTALLATION

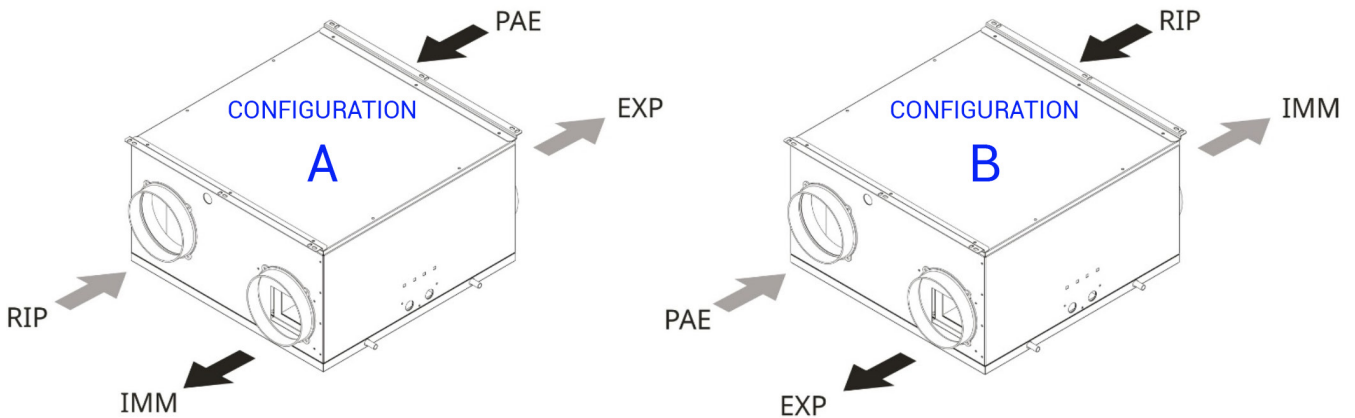

VERTICAL INSTALLATION

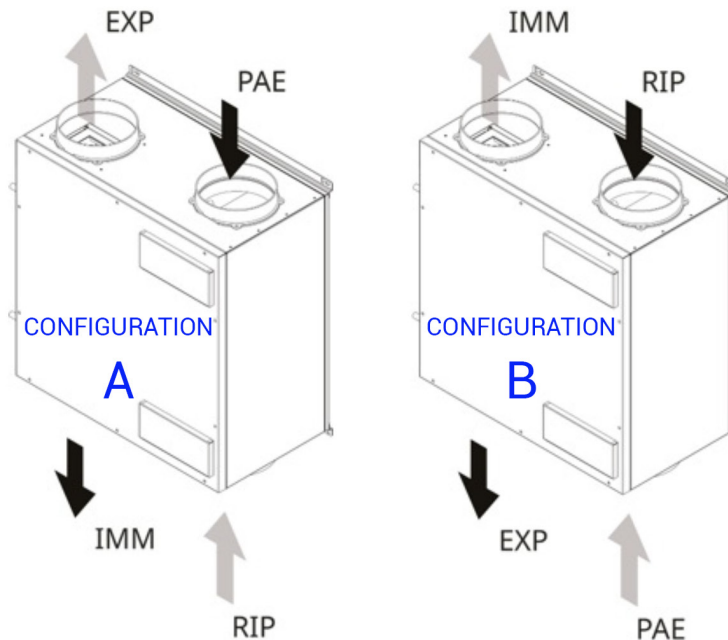

Reference	Description
PAE	Fresh air
EXP	Exhausted air
IMM	Supply air
RIP	Extracted air

GENERAL TECHNICAL DATA

EVHRP SMALL		10 H/V	15 H/V	25 H/V
Type of Fans		Forward curved centrifugal - Bushless electronic motor directly coupled		
Number of fans	Nr.	2		
Air flow	m ³ /h	130	210	320
Pressure drop	Pa	100	100	100
Heat exchanger (Data referred to the UNI EN 13141-7 standard Internal temperature 20 °C Internal humidity 28% - External temperature 7 ° - External humidity 72%)				
Type of exchanger		Counter-current plates - polypropylene material		
Number of Exchangers	Nr.	1		
Recovery efficiency	%	87	85	85
Type of filters		Flat Filters		
Filtration class		ePM1 70-80%		
Acoustic data (Data referred to UNI EN 3741 and UNI EN 3744)				
Sound power Lw transmitted by the structure	dB(A)	48	51	52
Sound power Lw radiated into the canal	dB(A)	55	57	60
Average sound pressure Lp to 1 Mt	dB(A)	41	43	45
Average sound pressure Lp to 3 Mt	dB(A)	34	36	38
Electrical Data				
Supply voltage		230 / 1 / 50 Hz		
Current consumption	A	0,8	1,2	2,2
Absorbed power	W	95	130	180
Degree of protection	IP	X0	X0	X0
Dimensional without aesthetics				
Width	mm	580	580	580
Depth	mm	580	580	580
Height	mm	255	255	315
Connection diameter	mm	160	160	160
Condensate drain	mm	12	12	12
Weight	kg	19	19	23

AEREAULIC PERFORMANCE AND THERMAL EFFICIENCY:

EVHRP SMALL 10 H/V

AEREAULIC PERFORMANCE

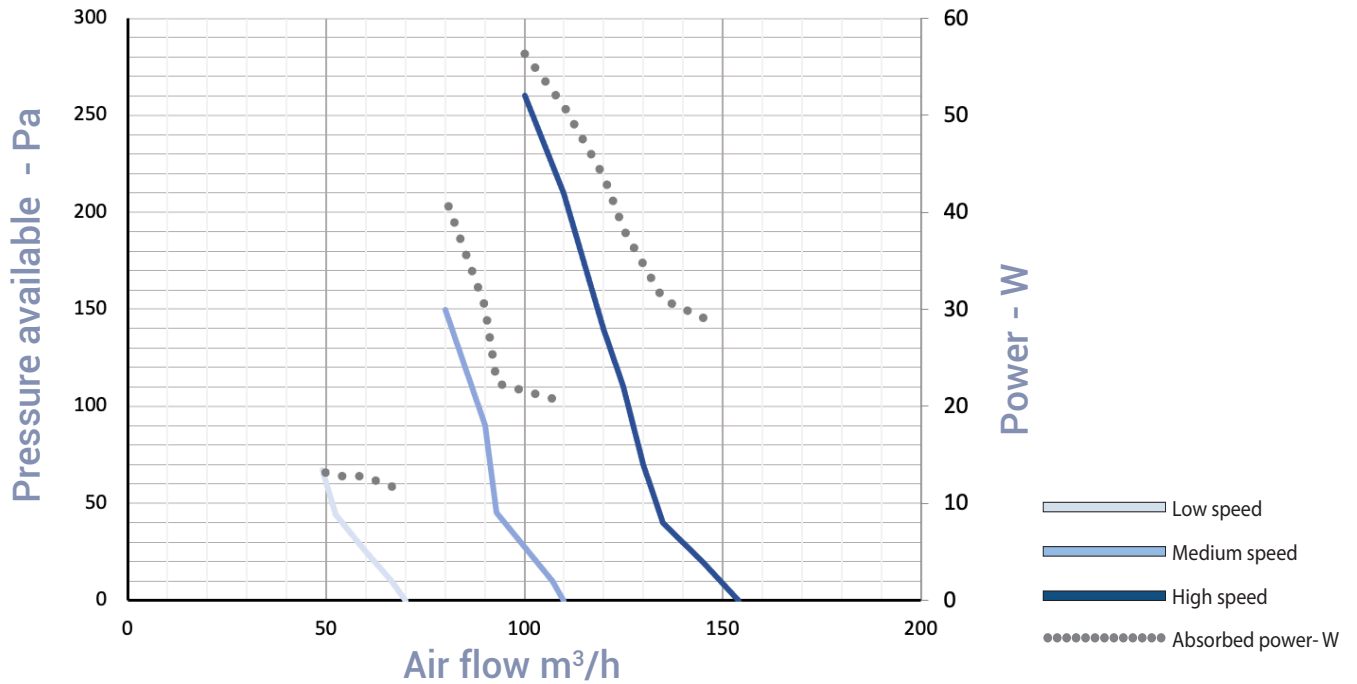

WINTER thermal efficiency¹

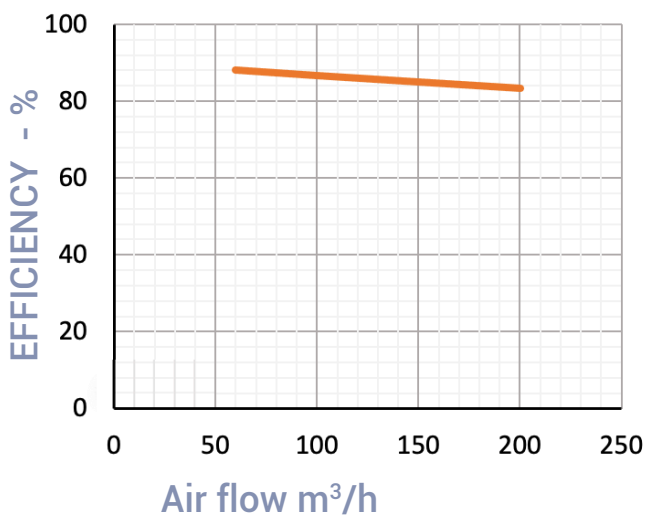

SUMMER thermal efficiency²

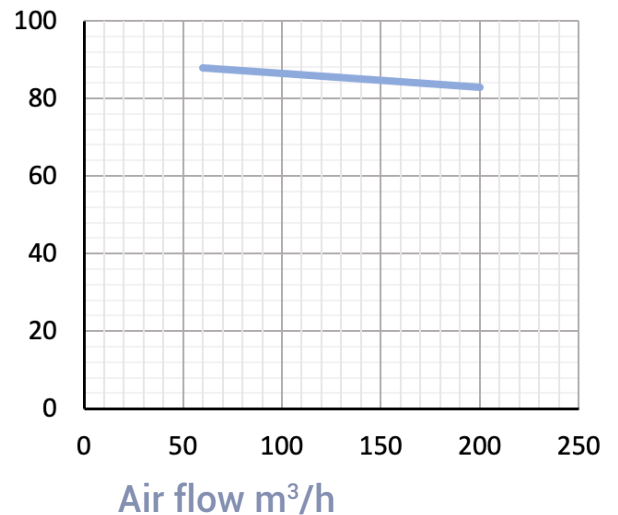

(1) Curves referred to the following conditions (UNI EN 13141-7): External air 7 °C - 75% RH - Internal air 20 °C - 37% RH
 (2) Curves referred to the following conditions (UNI EN 13141-7): External air 35 °C - 40% RH - Internal air 27 °C - 47% RH

AERAILIC PERFORMANCE AND THERMAL EFFICIENCY:

EVHRP SMALL 15 H/V

AERAILIC PERFORMANCE

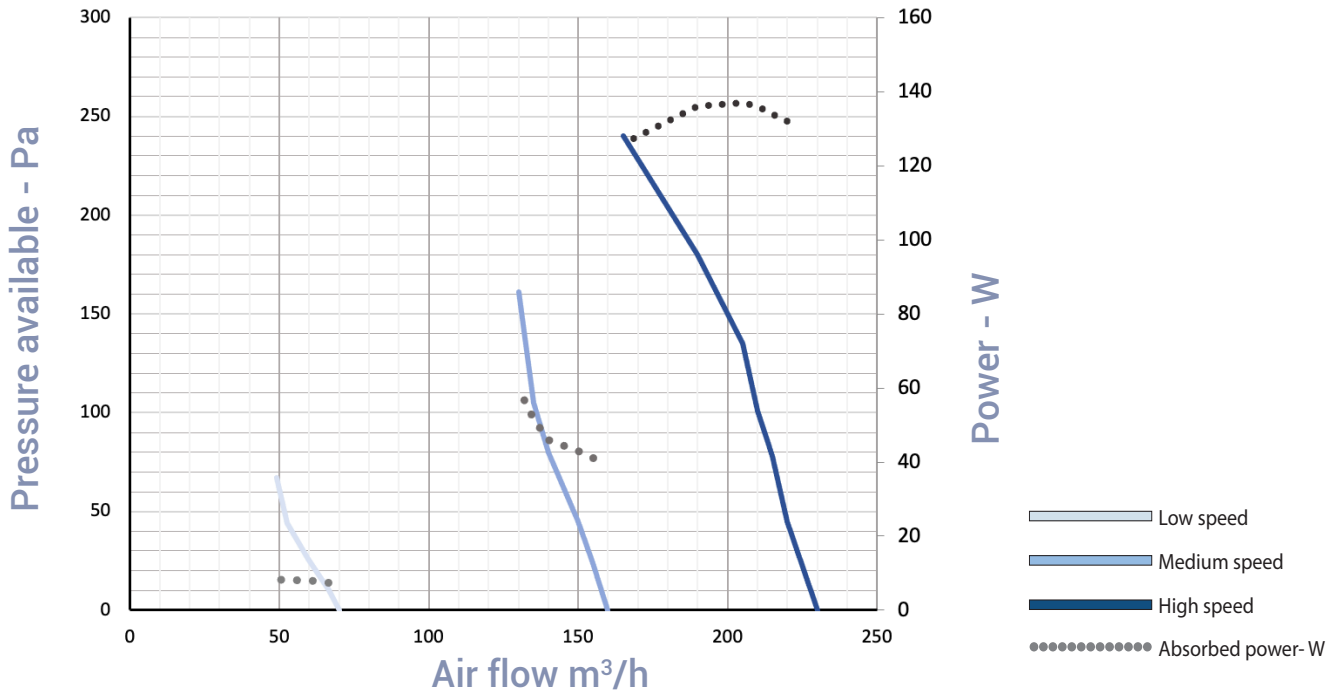

WINTER thermal efficiency¹

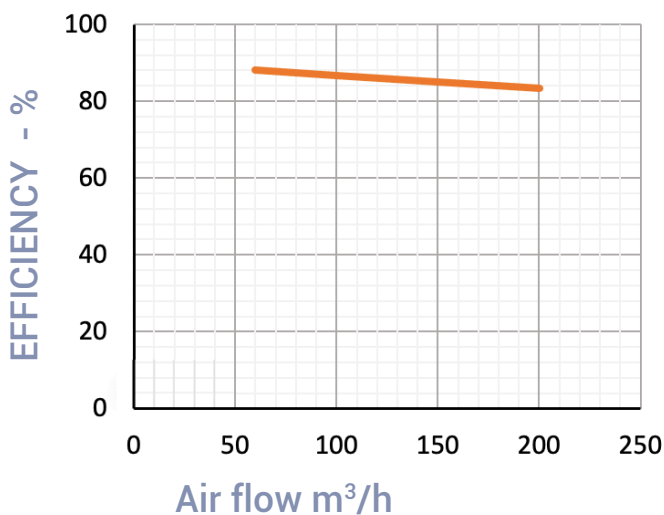

SUMMER thermal efficiency²

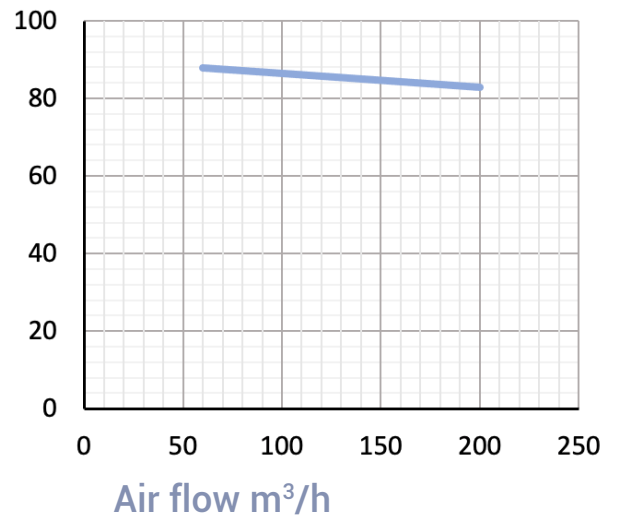

(1) Curves referred to the following conditions (UNI EN 13141-7): External air 7 °C - 75% RH - Internal air 20 °C -37% RH
 (2) Curves referred to the following conditions (UNI EN 13141-7): External air 35 °C - 40% RH - Internal air 27 °C -47% RH

AEREAULIC PERFORMANCE AND THERMAL EFFICIENCY:

EVHRP SMALL 25 H/V

AEREAULIC PERFORMANCE

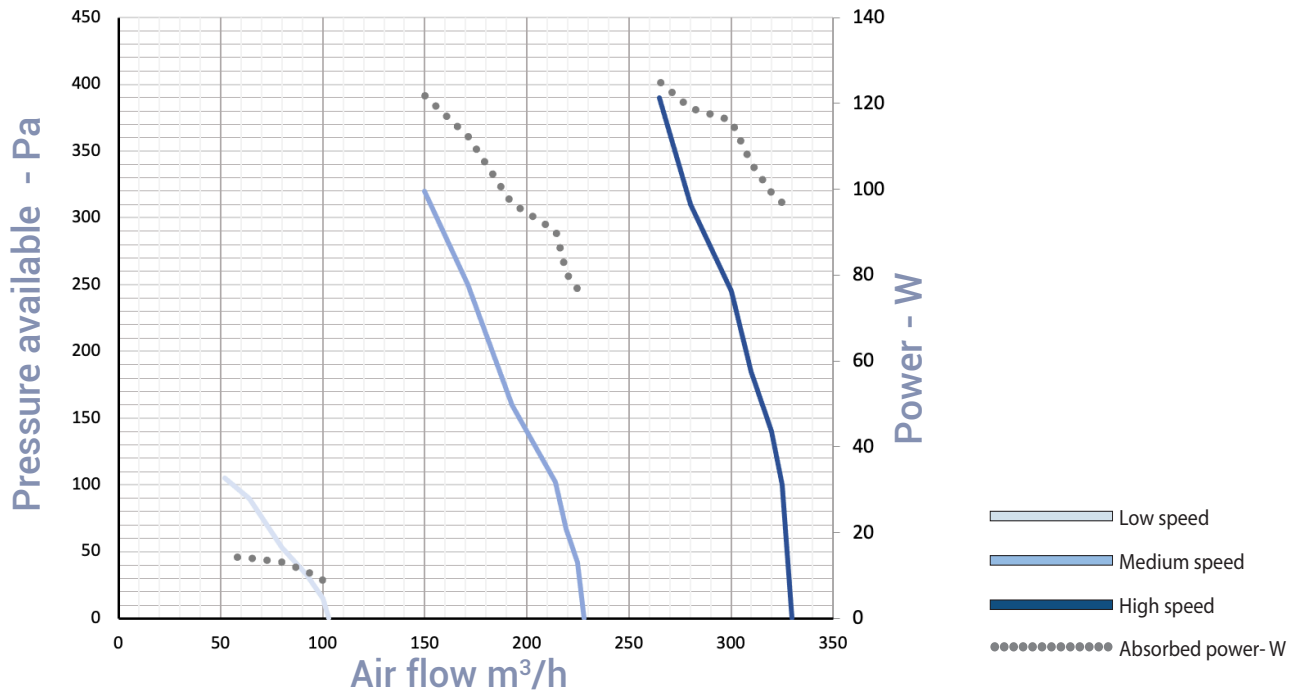

WINTER thermal efficiency¹

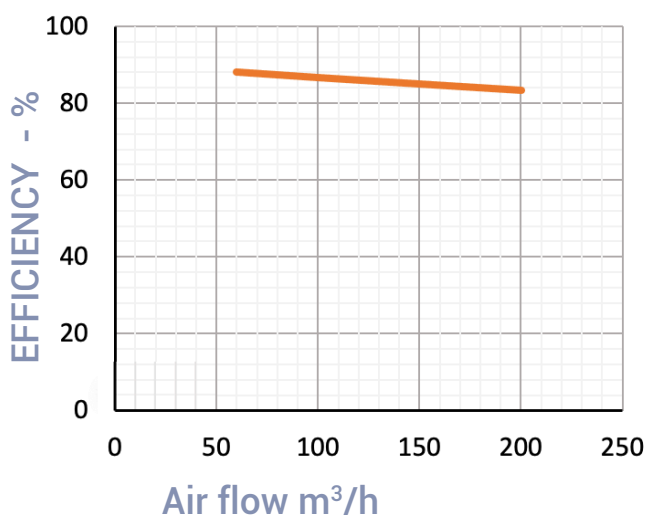

SUMMER thermal efficiency²

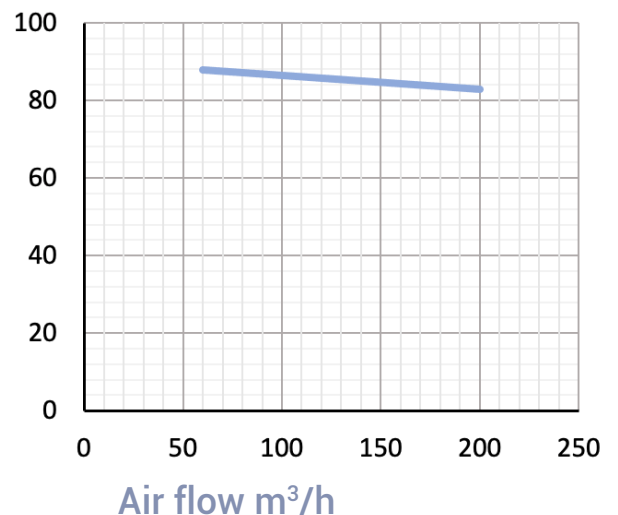

(1) Curves referred to the following conditions (UNI EN 13141-7): External air 7 °C - 75% RH - Internal air 20 °C - 37% RH
 (2) Curves referred to the following conditions (UNI EN 13141-7): External air 35 °C - 40% RH - Internal air 27 °C - 47% RH

EVHRP SMALL 10-15 DIMENSION:

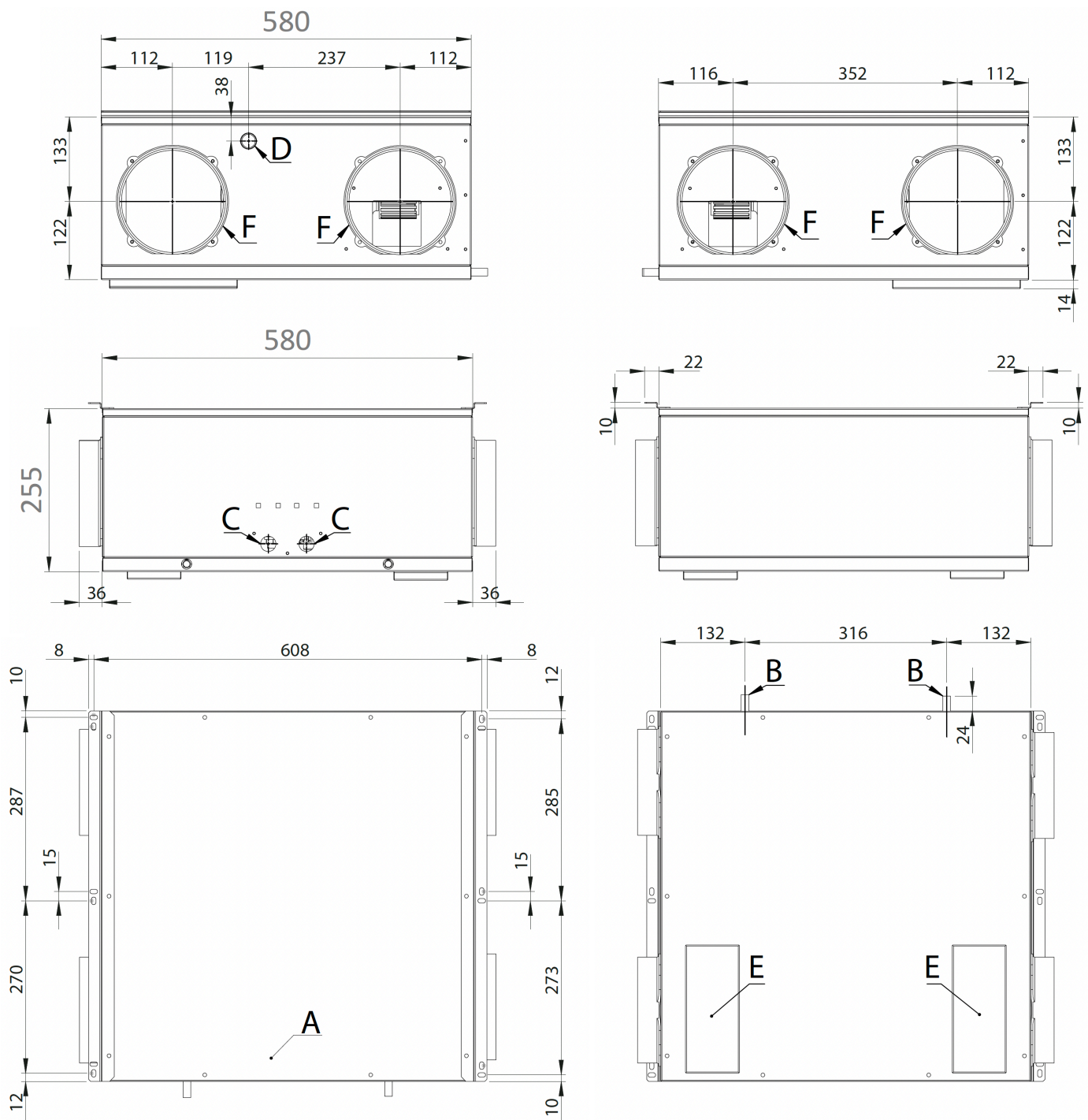

Reference	Description
A	Electrical cabinet
B	Horizontal installation condensate drain
C	Passage of power supply and display cables
D	Vertical installation condensate drain
E	Filter doors
F	Circular connections Ø 160mm

EVHRP SMALL 25 DIMENSION:

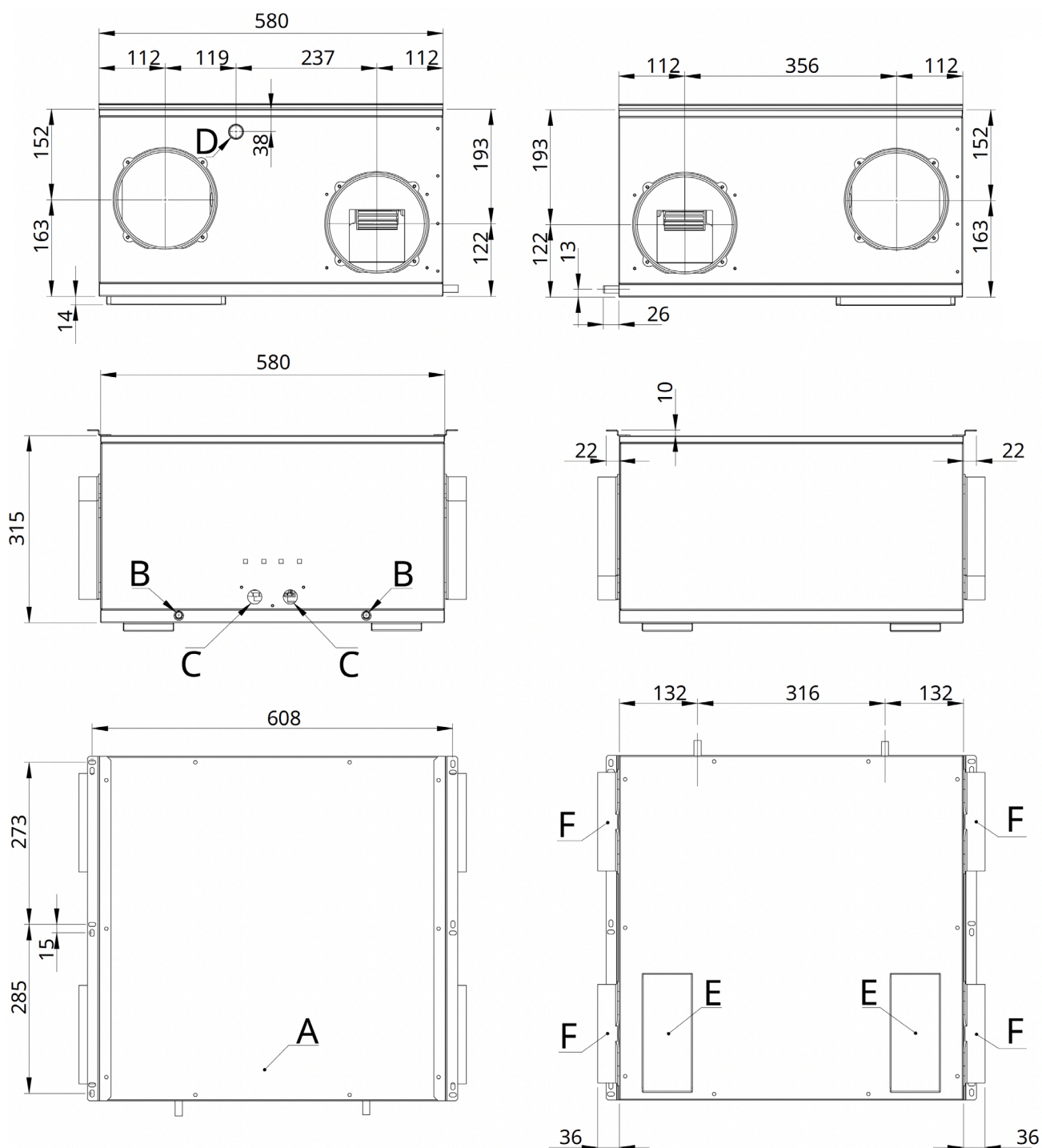

Reference	Description
A	Electrical cabinet
B	Horizontal installation condensate drain
C	Passage of power supply and display cables
D	Vertical installation condensate drain
E	Filter doors
F	Circular connections Ø 160mm

HORIZONTAL INSTALLATION

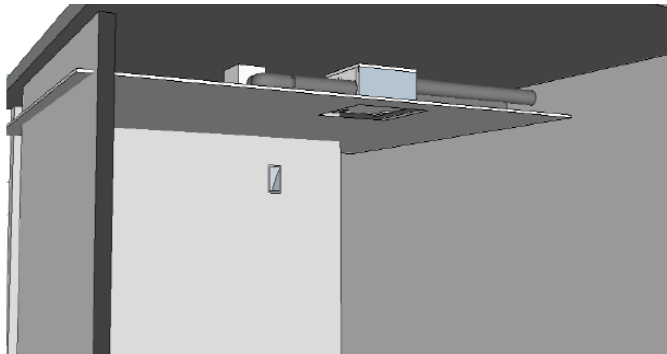
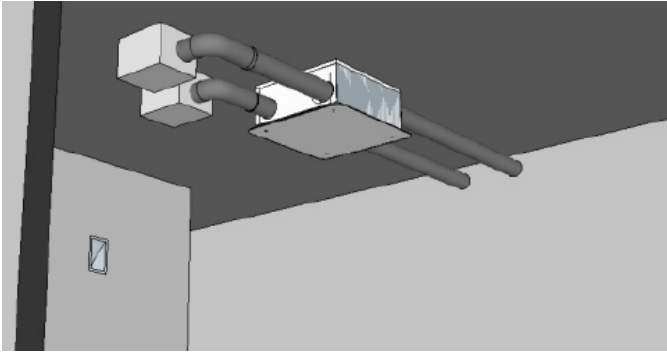

VERTICAL INSTALLATION

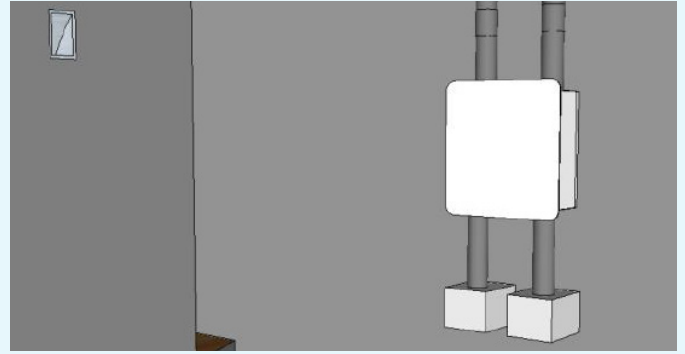

RECESSED VERTICAL INSTALLATION:

FORMWORK VERSION UI EVHRP SMALL CONFIGURATION A EXTERNAL AIR KIT		FORMWORK VERSION US EVHRP SMALL CONFIGURATION B EXTERNAL AIR KIT	
EXPULSION	EXTERNAL AIR INTAKE	SUPPLY AIR	AIR INTAKE
SUPPLY AIR	AIR INTAKE	EXPULSION	EXTERNAL AIR INTAKE



FORMWORK DIMENSIONS

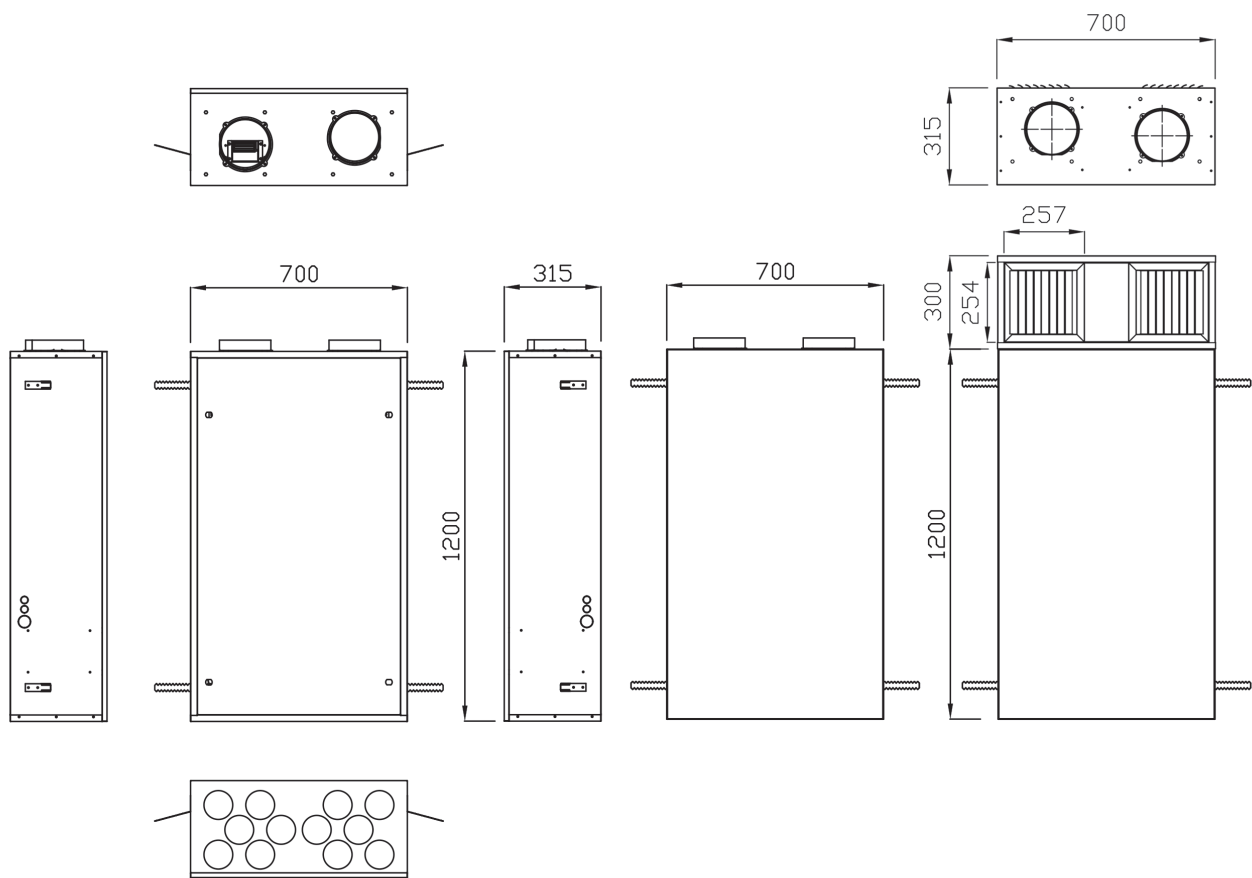

ERP DATA ECODESIGN

A	Supplier's name or brand					
B	Model identifier			EVHRP SMALL 10	EVHRP SMALL 15	EVHRP SMALL 25
C	Version			Central demand control /Versione IN (Regolator UR / Voc - Co2 integrated)		
	SEC CLASS	Kwh/mQ	COLD	-72,0	-75,1	-73,80
			AVERAGE	-34,3	-38,3	-36,30
			WARM	-10,1	-14,6	-12,19
SEC CLASS						
D	Type declared			UVR - Bidirectional	UVR - Bidirectional	UVR - Bidirectional
E	Drive type installed			Speed variator	Speed variator	Speed variator
F	Heat recovery system			In recovery	In recovery	In recovery
G	Thermal efficiency of heat recovery	%		85,2	82	84,6
H	Maximum capacity	m³/s		0,038	0,052	0,088
I	Electrical power absorbed at maximum flow rate	W/h		95	130	250
J	Sound power level	Lwa		49	50	52
K	Reference range	m³/s		0,027	0,037	0,0622
L	Reference pressure	Pa		50	51	50
M	SPI	W / mc/h		0,448	0,238	0,350
N	Control factor	CLTR		0.85	0,85	0,85
O	Maximum percentages of leakage declared	%		4,1 ext. / 3,1 int.	4,0 ext. / 2,9 int.	1,36 ext. / 1,6 int.
Q	Location and description of the signal related to the filter			Displayed on the unit and remote control display e on the instruction manual		
S	Internet address for disassembly instructions					

ITEM SPECIFICATIONS

EVHRP SMALL 10 - 15 - 25 H/V

Ventilation unit with very high efficiency heat recovery, compact size for ceiling or wall installation
Specific unit for ventilation in single residential buildings and collective apartments with low energy requirements
Tested and classified according to the European Ecodesign regulation ref. 1253/2015 and 1254/2014

CONSTRUCTION FEATURES

High resistance structure with self-supporting sheet metal frame

Internal parts in high density polystyrene compact size and low height for simplified installation with bottom panel easily accessible for maintenance and inspection.

Circular inlets diameter 160mm for connection to the air ducts

Quick and tool-free filter inspection and double drain for condensate evacuation with siphon supplied

Electrical panel, excluded from the air flow with management cards and control terminal blocks

forward curved centrifugal fans with EC motors with electronic control of air flow and low consumption

Static heat exchanger in polypropylene with counter-current flows for very high efficiency in recovering sensible or enthalpy heat

ePM1 class filters 80% with low pressure drop

by-pass for summer operation;

CHECKS AND ADJUSTMENTS

IN2 versions: with electronic card for speed management at 3 steps, it works antifreeze and automatic bypass. Remote touch wall panel on box 503.

Temperature sensors on the machine and possibility of hot water auxiliary battery management.

Dethwea / air qualities integrated in the remote display.

EVCNV2-N: Evolved remote control with integrated sensors of humidity and voc/CO₂ black color.

EVCNV2-B: Evolved remote control with integrated sensors of humidity and voc/white color.

EVCNW2-N: Evolved remote control with integrated humidity and voc/CO₂ sensors, with integrated black Wi-Fi.

EVCNW2-B: Evolved remote control with integrated sensors of humidity and voc/CO₂ with integrated white Wi-Fi.

Version S: Cabular fans prepared in the unit. Connecting for remote control EVTDV or potentiometers card by the installer.

ACCESSORIES:

EVBERD

ELECTRIC HEATING BATTERY COMPLETE WITH REGULATION (FOR POST-HEATING OR PRE-HEATING OPERATION)

The electric pre / post heating units with circular section consist of a galvanized sheet metal frame with armored resistance.

They are fitted with circular flanges which facilitate installation on the duct.

The side electrical box already complete with cable gland allows access to the components inside:

- Automatic reset thermal protector;
- Manual reset thermal protector;
- Throttle;
- Adjustable thermostat -35 +35
- Terminal block.

The thermostat mounted on the coil allows direct regulation of the supply air temperature

IMPORTANT: The water coil has 125 mm diameter inlet and outlet air flow connections, while the recuperator outlets are 160 mm in diameter. For installation, provide concentric reductions from diameter 160 mm to 125 mm and the corresponding female sleeves.



EVBERD 1

Unit model		EVHRP SMALL 10 H / V - EVHRP SMALL 15 H / V - EVHRP SMALL 25 H / V
Nominal electrical power	kW	0,8
Supply	/	230 V / 1 / 50 Hz
Absorption	A	2.2
Diameter	∅	125

EVBH WATER HEATING AND COOLING COIL COMPLETE WITH CONDENSATE TANK

The water pre / post heating units consist of a galvanized sheet metal frame and a heat exchange coil composed of copper pipes and aluminum fins. They are fitted with circular flanges which facilitate installation on the duct. They are equipped with threaded connections including valves for air vent and battery drain.

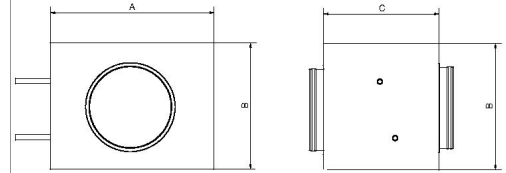
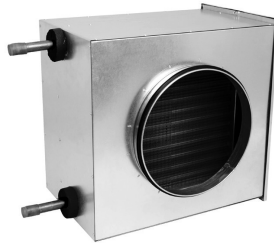

EVBH 1

IMPORTANT: The water coil has 125 mm diameter inlet and outlet air flow connections, while the recuperator outlets are 160 mm in diameter. For installation, provide concentric reductions from diameter 160 mm to 125 mm and the corresponding female sleeves.

Unit model		EVHRP SMALL 10 H/V - EVHRP SMALL 15 H/V - EVHRP SMALL 25 H/V
Nominal heat output (1)	kW	0.88
Nominal water flow (1)	m ³ /h	0.08
Water side pressure drop (1)	Kpa	3.9
Flow temperature (1)	°C	34.5
Sensible cooling capacity (2)	kW	0.52
Latent cooling capacity (2)	kW	0.4
Nominal water flow (2)	m ³ /h	0.16
Water side pressure drop (2)	Kpa	15.1
Flow temperature (2)	°C	15.4
Air side pressure drop	Pa	8
Height (B)	mm	150
Width (A)	mm	300
Depth (C)	mm	250
Entry diameter	Ø	125
Water connections	Ø	1/2"

* (1) Yields and technical data with nominal flow rates and temperatures: - Water IN / OUT - 50 ° / 40 ° - Air IN 20 ° / 50%

* (2) Yields and technical data with nominal flow rates and temperatures: - Water IN / OUT - 7 ° / 12 ° - Air IN 25/60%

COMANDO PER VERSIONI -IN2-

EVCNV2

Remote panel for mounting on box 502-503 or on the wall;
Speed, temperature and operating modes control;
Maximum connection length 50mt if made with 4-wire braided shielded cable.



EVCNW2

Remote panel for mounting on box 502-503 or on the wall;
Speed, temperature and operating modes control;
Maximum connection length 50mt if made with 4-wire braided shielded cable.

Wifi control for management via smartphone or tablet and dedicated APP;



CONTROL FOR S VERSIONS

EVTDV

Remote panel for mounting on a European thermostat box 80x80mm;
0-10v fan speed control, dirty filter timer, manual bypass control, Speed control and silent running functions;
Can be combined with the SQV air quality probe
Maximum connection length 50mt if made with 4-wire braided shielded cable.

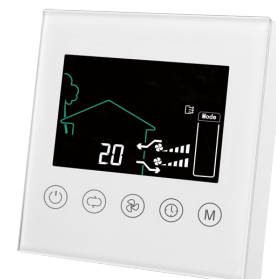

AIR QUALITY PROBE EVSQV FOR VERSION S

Air quality probe for wall mounting or European thermostat box
80x80mm;
Control of VOC parameters that can be set for automatic
ventilation adjustment;
Can only be combined with the TDV command;
Maximum connection length from TDV 50mt if made with 4-wire
braided shielded cable.



ACCESSORIES FOR VERSION I/S ACTIVE FILTER

Active filter consisting of an F7 filter media activated with mini
activated carbon granules;
Recommended for areas with a high rate of contaminating
gases in the outdoor air (VOC, PAC, OZONE, SO2, NOX)
The activated carbon filter must be replaced regularly to ensure
its effectiveness.



SPARE FILTERS FOR VERSION IN/S

Kit consisting of two filters ePM1 70/80% pfilters for unit
maintenance;; the filters are easily removable through the
dedicated inspectionable ports;



CE marking

The CE marking (present on each machine) certifies compliance with the following
Community standards:

- Low Voltage Directive 2014/35 / EC
- Electromagnetic Compatibility Directive 2014/30 / EC
- Ecodesign 2009/125 / EC